

Surface vitrée: 148.412 po²

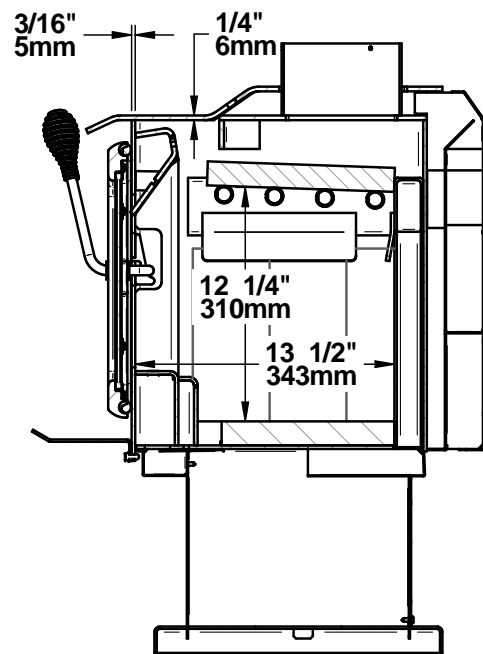

SECTION A-A

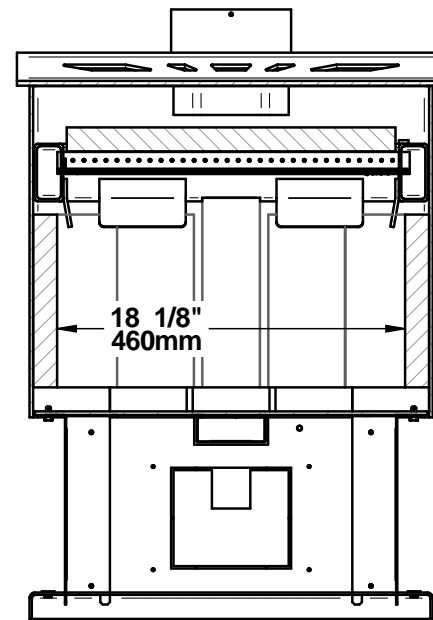

SECTION B-B

